



Sovitron Interior Pvt.Ltd.



Model Name	Glass Pendant / DL-CGL09-9
Description	Decorative Light

Technical description	Image
-----------------------	-------

Dimension	Dia=500mm H=175mm
Frame	Glass
Color Tempertaure	3000K
Power	9W
Total Luminous Flux	630 lm
Efficacy	70 lm/W
IP rating	20
Color Rendering	≥80
Mounting	Pendant
Optics	E27 Holder
Dimming	NON-Dimmable
Operating Voltage	220-240 VAC
Standard Lifetime	L70 minimum at 50,000 burning hours



Dimension diagram

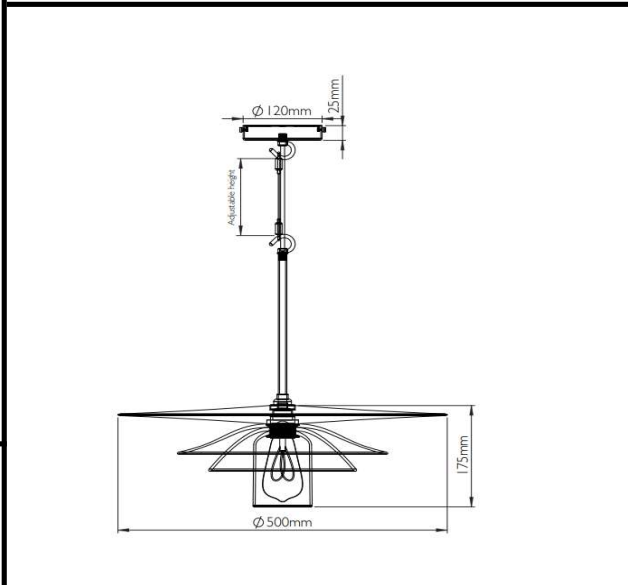

Remarks:-

Address: Plot #7 Saroorpur-Nangla Industrial Area,Ballabgarh-Sohna Road,Faridabad-121005
Email: info@sovitron.com